

Application of Phase Change Material For Energy Efficiency - A Review

Anant Nimje¹, K K Ghosh², Col R N Ballaney³
^{1, 2, 3}(Faculty of Electrical and Mechanical College of Military Engineering,Pune)
 Corresponding Author : Anant Nimje1

Abstract : The phrase climate change , global warming and more recently global cooling is increasing due to its relevance with global climatic conditions and environmental impacts. Energy is and will continue to be a primary engine for economic development. The 80% percent of the world's population lies in the developing countries, their energy consumption amounts to only 40% of the world total energy consumption. Due to high standards of living in the developed countries there has been a rapid rise in the use of energy resources and consequently greenhouse gases (GHGs) emissions .Researcher observed that the demand of electricity in building is increased by 1.8% per year until 2050. Hence today's major issues of concern to governments and societies are nothing but promoting energy efficiency technology and conservation of energy in buildings

. Phase change materials (PCMs) are considered as a possible solution for reducing the energy consumption in new and existing residential buildings. Due to the unique characteristic of PCMs such as high storage densities and latent heat properties they provide opportunities for greater energy storage in many applications for residential buildings. This paper reviews recent development of PCM application and its potential for reducing energy consumption for heating and cooling due to reduced indoor temperature fluctuations, the load reduction/shifting, and increased indoor thermal comfort .

Keywords: Martial Properties ,Thermal Properties

I. Introduction

In todays world a prime objective for energy policy is the energy efficiency of buildings. Due to increase in the living standard and comfort the total energy consumption of buildings is around 40% which produces nearly 40% of the total CO2 emissions .In order to maintain thermal comfort the conventional cooling system consumes sufficient amount of energy and increases associated GHG emissions [1].So while promoting energy efficiency and sustainability of buildings the energy reduction and energy conservation is of great importance. The electricity demand of the building increasing at the rate of 1.8% annually ,will exceed 180 exajoules by 2050 if not controlled . Heating, ventilating and air conditioning (HVAC) systems account for 60% of the total energy consumed in buildings. The passive cooling systems are considered as a primary backbone of sustainable building concepts because they encompass the mitigation of energy consumption and GHG simultaneously[2].Building cooling methods can be classified into three major groups which includes active, passive and hybrid system. Active cooling methods cover all conventional HVACs (e.g., AHU and chillers).Whereas the passive cooling technology involves , utilization of natural energy available

from environment rather than the consumption of conventional energy resources[3]. Hence Passive cooling of the buildings refers to cool the building interior with or without minimum electricity usage.Passive cooling technique according to the natural source can be classed as shown in Fig.1 [4] Nowadays,the thermal energy storage (TES) systems could be

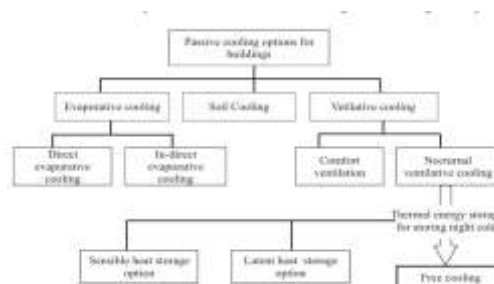

Fig. 1: Fig shows Passive cooling technique [4]

used, to supply heat reliably and to contribute efficient energy use. The main advantage of using thermal storage is that it can maintain the match between supply and demand when they do not coincide in time[5]. The best known method of TES in buildings involves sensible heat storage, by changing the temperature of a storage material, which can be used for the storage and release of thermal energy in a passive way. Whereas latent heat storage works on the principle of change in phase of storage material. In this larger volume of material is required to store the same amount of energy. Hence, by incorporating PCMs in passive LHTES systems of buildings walls, windows, ceilings or floors the buildings energy consumption for heating and cooling can be effectively reduced. Here passive means that the phase-change processes occur without resorting to mechanical equipment. As suggested by Sadineni et al.[6], environmental-friendly passive building energy efficiency strategies are the viable solutions to the problems of energy crisis and environmental pollution.

II. Phase Change Material

Phase change materials (PCMs) are assumed as unique materials that store and release heat by means of latent heat. PCMs were used as thermal energy storage (TES) for building to control temperature over a cycle period of 24 hours to charge and discharge the heat. The main property of phase change materials is the storage of heat energy in a latent form. When the ambient temperature rises, the chemical bonds of the material will break up whereby the material will change from solid to liquid. This phase change is an endothermic process and during this process absorption of heat takes place. As the ambient temperature drops again, the PCM changes phase from liquid to solid state and releases the absorbed heat. This phase change is an exothermic process. The cyclic process results in stabilised inside temperature, cuts off-peak cooling loads and decreases heating loads. This can be achieved not by affecting the thermal resistance of the building envelope but by influencing the (surface) temperatures[7]. Fig. 2 shows conceptual diagram of PCM phase change process.

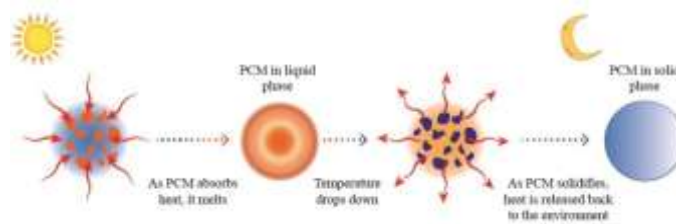

Fig. 2: Fig shows conceptual diagram of PCM phase change process

A. Classification

Material phase change can be classified into four states: solid-solid, solid-liquid, gas-solid and gas-liquid. For practical purposes, only the solid-liquid variety can be used for building cooling or heating because the other varieties have technical limitations[9], [10]. Phase change materials can be categorised in three groups: (i) organic compounds, (ii) inorganic compounds and (iii) inorganic eutectics or eutectic mixtures as shown in Fig. 3. Each group has its typical range of melting temperature and melting enthalpy as shown in Fig. 4. [7]



Fig. 3: Fig shows different types of PCM

1. Organic phase change compounds Organic phase change materials are chemically stable, do not suffer from super-cooling, non-corrosive, non-toxic and have a high latent heat of fusion. Organic PCMs can be subdivided in two groups paraffins and non-paraffins .

Paraffin Compounds :Commercial paraffin waxes $CH_3 (CH_2)_n CH_3$ are inexpensive and have a reasonable thermal storage density of 120 kJ/kg up to 210 kJ/kg. Paraffins are available in a wide range of melting temperatures from approximately $20^\circ C$ up to about $70^\circ C$, they are chemically inert, have a low vapour pressure in the melt and do not undergo phase segregation. Paraffin materials are also considered to be safe, reliable, cheap and to have a high latent heat[12].Paraffins are flammable and not being compatible with plastics. ,have low thermal conductivity of about $0.2 W/(m K)$ which limits their application[11] and have a large volume change during the phase transition[13].

Non-paraffin Compounds: The non-paraffin organics include fatty acids, esters, alcohols and glycols. They have generally excellent melting and freezing properties, but they are expensive than paraffins [13]. In addition, they can be corrosive and exhibits reproducible freezing and melting properties with no super cooling during freezing[48].One of drawbacks of this PCM type is its high flammability. In this sub-category, fatty acids display high latent heat, low super cooling, no phase segregation and different melting temperature[14].

2. Inorganic phase change compounds Inorganic PCMs have high heat of fusion, good thermal conductivity, cheap and non-ammable. This category includes salt hydrates, salt solutions and metals.Hydrated salts are attractive materials for thermal energy storage due to their high storage density of about 240 kJ/kg, high thermal conductivity of about $0.5 W/(m K)$ and their reasonable cost compared to parafn waxes. Most known is Glaubers salt or $Na_2 SO_4 H_2 O$ with a melting temperature between $32^\circ C$ and $35^\circ C$ and a high latent heat of

254 kJ/kg as one of the cheapest materials that can be used for thermal energy storage, but it's application is limited due to supercooling and phase segregation problem [11].

3. Eutectics Eutectic PCMs consist of a combination of at least two other PCMs. Eutectic mixtures or eutectics, i.e. a mixture of multiple solids in such proportions that the melting point is as low as possible have in general sharp melting points and its volumetric storage density is slightly higher than that of organic compounds[7]. Eutectics may be divided in 3 groups according to the materials of which they consist: (i) organicorganic, (ii) inorganicinorganic and (iii) inorganicorganic eutectics.

Figure 4 shows the difference in melting enthalpy and melting temperature for some of the most common materials used as PCMs.

B. Properties of PCMs

The first property to consider when deciding on a suitable material for any given application is that of melting temperature.From a physical point of view, the melting point of the PCM

should be in the range of $10^\circ C$ to $30^\circ C$ to provide thermal

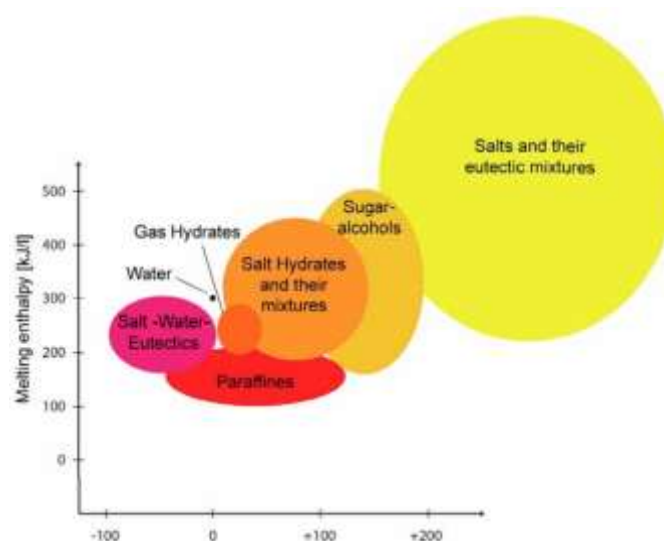

Fig. 4: shows Melting enthalpy versus melting temperature for various materials used in PCMs[8]

comfort for occupants. This temperature should be selected with respect to average day and night temperatures and other climatic conditions of the building site [16], [14]. Thermodynamically, the PCM should have high latent heat per volume unit, which is an important factor in building applications because it means that with lower volume, the PCM can absorb/ release higher amounts of energy with a lighter building envelope [18]. Moreover, it should also have a large specific heat capacity (C_p) [21]. Another significant thermodynamic factor is its heat transfer ability (conductivity). Chemical properties are chemical stability, low volume expansion and low/no super-cooling during freezing. The PCMs should be non-toxic, non-corrosive, non flammable and non-explosive [17], [18], [22]. A PCM needs to have a reasonable price and availability on the market.



Fig. 5: shows characteristics for Selection of PCMs [2].

III. Methods To Measure The Thermal Properties Of Pcms

The performance of the PCM directly depends on the thermal properties. The data provided by the PCM manufacturers could be erroneous, uncertain and higher range. Hence measurements must be done in order to verify the data provided and to get the actual thermal properties of the PCM. The thermal properties of PCMs can be determined by (i) differential scanning calorimeter (DSC) and (ii) differential thermal analysis (DTA).

Differential Scanning Calorimeter (DSC)

The heat of fusion, the heat capacity and the melting/freezing temperature can be obtained using the DSC technique. The principle of the test is to keep a temperature equilibrium between the test sample and a reference sample [7]. DSC method allows to measure the quantity of heat absorbed or released by a body as result of change in temperature (heat transfer by conduction), in which the difference in the amount of heat required to increase the temperature of two different samples in identical conditions (a sample and a reference sample) is measured as a function of temperature. For PCMs, the DSC gives the melting and freezing curves and the associated heats.

Differential Thermal Analysis (DTA)

DTA technique is an alternative technique to DSC in which the heat applied to the sample and the reference remains the same rather than the temperature [29]. DSC measures the energy required to keep both the sample and the reference sample at the same temperature while DTA measures the difference in temperature between the sample and the reference sample when they are both subjected to the same heat. T-history method

The T-history method proposed by Zhang and Jiang [24] is a simple method for determining the melting point, heat of fusion, specific heat and thermal conductivity of PCMs. Temperature-time curves of the PCM samples are drawn and their thermophysical properties are obtained by comparing the curves with temperature-time curve of the other known material served as reference (usually pure water).

IV. Building As A Thermodynamic System

From the sustainability point of view buildings should be designed to ensure thermal comfort of occupants with a minimum energy for heating and cooling. If the proper PCM is selected for building envelope, delay in outdoor temperature occur, leading to indoor air temperature in comfort zone. Hence a passive ideal energy conservation building with an envelope can be possible [26].

The building is a complex thermodynamic system and it is difficult to attain passive ideal energy conservation building. External factors such as air temperature, wind speed, solar radiation and internal factors due to internal loads and internal heat source influence the indoor air temperature fluctuation. The indoor air temperature is closely related to building's envelope material properties such as thermal resistance and heat capacity. In the building's envelope, TES attain more energy efficient buildings using PCMs. They provide

a large heat capacity and more energy storage in the building's envelope, because of latent heat loads involved in the phase- change processes.

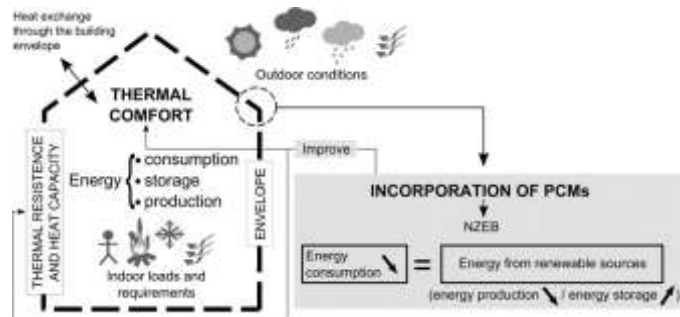

Fig. 6: NZEB as a thermodynamic system and potential of PCMs to reduce the energy consumption and to enhance the indoor thermal comfort. [1].

The building's envelope as shown in fig6. is the boundary of the system and the balance between the energy production within the building (or nearby), the energy consumption and the energy storage during the operational phase of the building is shown. This balance is influenced by the internal and external loads, and also by the thermal resistance and heat capacity of the envelope. The incorporation of PCMs in construction elements enhance the energy storage capacity of the building, helping to reduce the energy consumption for heating and cooling in a passive and sustainable way.

A. Thermal Energy Storage in buildings envelope Lin et al. [47] observe that when buildings HVAC systems can be integrated with PCMs they act as thermal energy storage unit which in turn enhance the systems efficiency. Kuznik and Virgone et al [25]. discovered that the PCM filled walls greatly reduced the overheating effects of the room and thus lowering the surface temperature of the wall . The results show that PCMs could also be used to increase occupant comfort in buildings as well as store energy.Zhou et al.[29] have conducted extensive research on PCMs.They found that PCMs have a great potential in reducing fluctuations of indoor temperatures in buildings, as well as offer thermal storage and ventilation/cooling

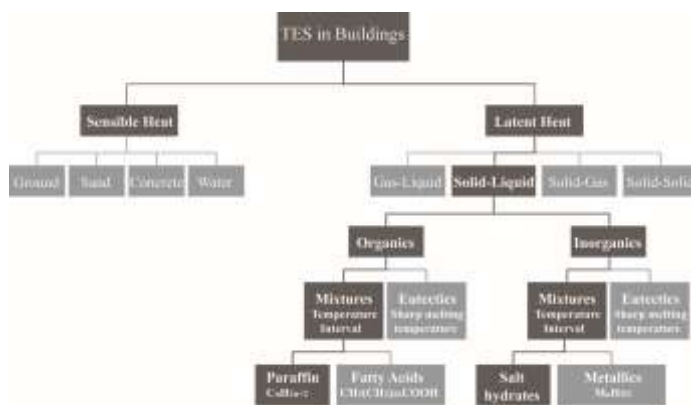

Fig. 7: Different types of thermal energy storage using in buildings envelope

Thermal energy storage in buildings mainly occurs through a change in internal energy of a material as sensible heat or latent heat or a combination of both of these. A diagrammatic overview of major techniques for thermal energy storage using solar radiation as most potential infinite sources of energy is shown in Fig. 7. Phase change materials (PCMs), as innovative thermal storage systems, can absorb heat energy from inside the building and release it to the outdoors. PCMs could save HVAC system energy usage in the range of 10% to 30% in different weather conditions.[2]

B. Methods of thermal energy storage

Thermal energy storage (TES) systems store energy in thermal form for utilization at a later time. The TES systems involve three main steps: thermal charging, thermal storing and thermal discharging. Materials can reserve heat in three primary ways, including sensible heat, latent heat and chemical reactions (Fig.) [2]. In sensible heat storage (SHS), heat can

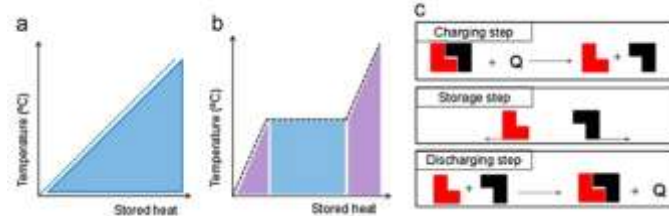

Fig. 8: A comparison between (a) sensible heat and (b) latent heat storage and (c) chemical storage [49]

be stored with the increase in temperature of the material. The principal factors that determine the amount of heat storage capacity of the SHS, are specific heat of the medium, temperature variation and the quantity of the material as shown in Eq. (1) Whereas in , in latent heat storage (LHS), thermal energy

$$Q = \int_{T_1}^{T_2} mC_p dT = mC_p(T_2 - T_1) \quad (1)$$

is reserved (or released) when the phase of the material changes from one state to another (e.g., solid to liquid). The amount of stored energy can be determined by the materials

$$Q = \int_{T_1}^{T_m} mC_p dT + ma_m \Delta h_m + \int_{T_m}^{T_2} mC_p dT \quad (2)$$

$$Q = m [C_{sp}(T_m - T_1) + a_m \Delta h_m + C_{lp}(T_2 - T_m)] \quad (3)$$

used for latent heat energy storage i.e. PCM which have the characteristic of absorbing or releasing thermal energy via temperature variations in controlled conditions [2]. In contrast to customary construction materials (e.g., concrete), PCMs can store thermal energy in both sensible heat as well as latent heat. For example, a wall with 25 mm thickness incorporated with PCM is able to reserve the same amount of thermal energy as a concrete wall with 420 mm thickness.

V. Methods Of Pcm Incorporation

It is important to evaluate how PCMs can be incorporate within passive LHTES systems (construction materials or building elements) to prevent leakage. Hawes et al. [27] considered three methods of incorporating PCMs in conventional construction materials (i) the direct incorporation (ii) the immersion and (iii) the encapsulation. Additionally, PCMs can also be used in the form of shape-stabilized PCMs.

1. Direct Incorporation and Immersion

In both direct incorporation and immersion methods PCMs incorporate directly in conventional building materials. Here the liquid or powdered PCM is directly mixed with construction materials such as gypsum, concrete or plaster during production [23], [29]. Whereas in immersion method, the porous construction material, such as gypsum board, brick or concrete block, is immersed into the melted PCM absorbing it by capillarity action. In both method the problems of long-term leakage and eventual interaction with some building structures is observed. [28].

2. Encapsulation In order to avoid the problem of leakage during PCM phase change an encapsulation of PCM is preferred [2]. In addition, encapsulation can prevent the low viscous liquids from diffusing throughout the material. Increasing the surface area, encapsulation increases the thermal conductivity, which means increasing the heat transfer between the PCM and surrounding environment. Moreover with encapsulation, PCM can be isolated from harmful environmental factors, checks compatibility between PCM and surrounding materials, reduce corrosion and control volume variation during state changes [2]. The classification of encapsulation is based on the size which encompasses the PCM: macro (with diameters of 1 mm and more), micro (from 1 m to 1 mm) nano (less than 1 m) [2] and bulk storage [30].

(i). Microencapsulation

The technique of Microencapsulation involves containing a high amount of micron sized PCM particles in rod-shaped, or spherical containers made of high molecular weight polymeric films[31] Tyagi et al. [32] dened the technique as the process by which

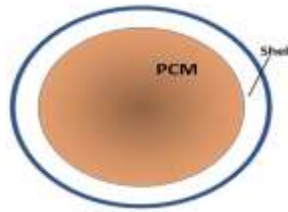

Fig. 9: Shows PCM particle

individual particles or droplets of solid or liquid material (the core) are surrounded or coated with a continuous film of polymeric material (the shell) to produce capsules in the micrometer to millimeter range, known as microcapsules. Two main parts can be observed in microencapsulation: the PCM, which is the core, and the shell, which can be a polymer or an organic substance. The shape of microencapsulation is not limited, it can be either a regular (e.g., tubular, oval or spherical) or an irregular shape [33].Due to the nature of microencapsulation, it tends to be high in cost when compared to other storage methods.

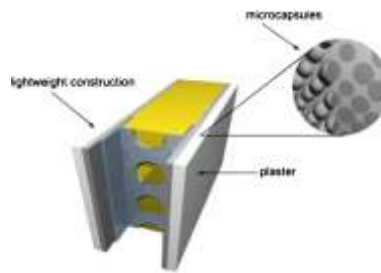

Fig. 10: Schematic view of a lightweight wall alongwith PCM

micro-capsules [36]

. However, the use of microencapsulation can be optimized by combining the PCM modules with the heat transfer fluid to form a phase change slurry (PCS) [31].

(ii). Macroencapsulation

The macroencapsulation is the technique in which PCMs are packaged in a container, such as tubes, spheres, panels, or other receptacles, and then incorporated into building elements . The thermal and geometric parameters of the container required for a given amount of PCM have a direct influence on the heat transfer characteristics in the PCM and affects the melt time and the performance of the PCM storage element [35]. In macroencapsulation PCMs are stored inside of a module



Fig. 11: Clay bricks with PCM macrocapsules[20] (which come in a variety of forms), and the heat transfer fluid

flows over the modules. Macroencapsulation provides a large flexibility for design, avoids phase separations, increase the rate of heat transfer, and provide a structure to hold the PCM in place that can be

disguised into its environment[30]

3.Laminated PCM board

PCMs can also contribute to produce stable composite materials by their diffusion into another phase of supporting materials, such materials are called as high-density polyethylene [1]. The laminated single layer PCM can be used as a building component like an interior partition or be incorporated in the envelope. Results from a practical observation shows that (i)17% reduction in time during heat recovery(ii)20-50% improvement in thermal fluctuations(iii)7-18% improvement in thermal conductivity which can be achieved using laminated PCM. Thus laminated PCM as a drywall possesses a better thermal performance [19].



Fig. 12: Left to right: a paraffin-based phase change material (PCM) within a polyester based panel from NovaTherm laboratory. installation of a DuPont Energain panel. Plate PCM

A new kind of , shape-stabilized PCMs (SSPCMs), has been an attraction for many researchers due to high specific heat, suitable thermal conductivity, the ability to keep the shape of PCM stabilized in phase-change process, and a good performance of long-term multiple thermal cycles[34]

VI. Application Of Solid-Liquid Pcms

When PCM is added to the building structure, it increases the thermal mass and prevents the heat from reaching the occupied space[2].

A. PCM for thermal comfort

PCMs not only show potential for energy savings but also highlight the benefits towards increasing the overall indoor thermal comfort. Lan et al.[37] showed a correlation between workers' performance and productivity compared to the sensation of thermal comfort due to shifting temperatures. Temperature fluctuations are reduced effectively with the installation of PCM. This will benefit the indoor climate in two ways. First, the temperature will be held more stable, reducing the feelings of thermal discomfort due to temperature fluctuations throughout the day. Second, the peak temperature will be reduced and should not reach a temperature which leads to increasing thermal discomfort.

B. PCM for Reducing HVAC loads/Peak Load Shifting

Peak loads during the day time put pressure on the electrical system because HVAC system is busy in handling higher heating or cooling loads. By shifting the peak load away from the peak hours of electrical demand using PCMs, the peak load may be divided throughout the day reducing the highest peaks

Through this process, a promising solution can be found for the mismatch correction between the supply and demand of electricity because PCM provides the opportunity to shift the

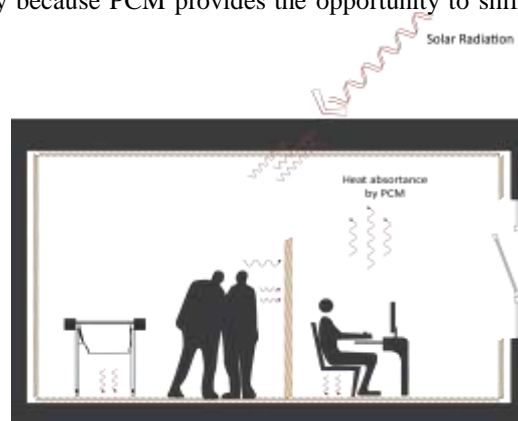

Fig. 13: PCM makes spaces more comfortable by alleviating surfaces temperature and effecting the mean

radiant and air temperature of the thermal zones.

energy demand from high cost tariff periods to off-peak times [2]. This is known as "peak shaving" or "peak shifting". PCM can provide the total cooling load during peak hours while the HVAC system is completely out of operation. Fig.16 depicts how the peak load reduced and shifted by the use of PCMs.

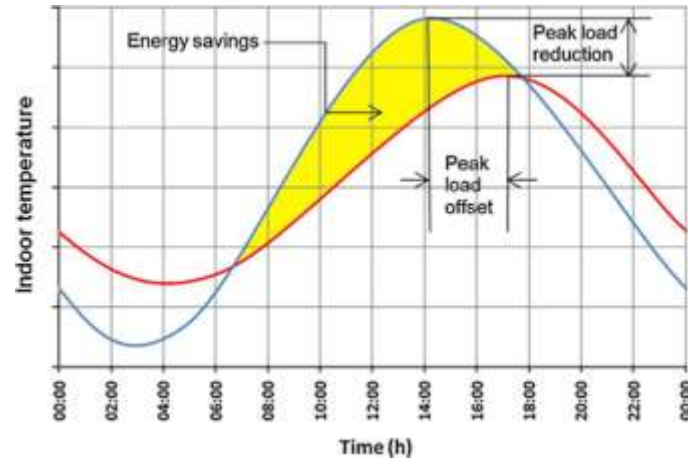

Fig. 14: shows reduction in peak load using PCM

C. Free cooling using PCM

Free cooling is one of the Passive cooling technique used for building using thermal energy storage system[38]. In free cooling, a storage medium is used to store the cold when the ambient temperature is colder than the room temperature .This stored cold is extracted from the storage medium, using an electric fan , whenever it is needed or during hot day time. [39], [40]. In free cooling thermal energy is stored either by changing the internal energy of the storage material (sensible heat storage) or by changing the phase of the storage material (latent heat storage) or the combination of both[41], [42] working principle: The working principle of PCM based free cooling for buildings is shown in Fig.17 which consists of following two modes of operation:

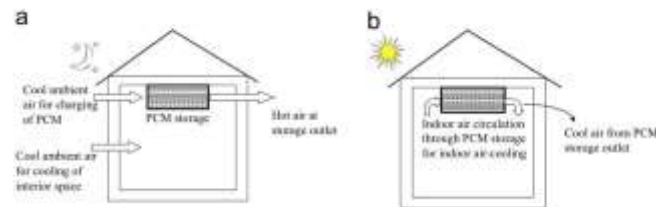

Fig. 15: Free cooling working principle . (a) Charging process (working of PCM storage during night time) and (b) Discharg- ing process (working of PCM storage during day time)

The cooling operation for PCM perform in two stages:

The charging stage or PCM solidification: In this step the heat transfers from the PCM to the ambient air(lower temperature) and phase change from liquid to solid takes place at constant temperature. This process stops when the temperature gradient (between the PCM and the indoor air) is insufficient to drive the transition.The discharging stage or PCM liquefying: During the daytime when the indoor temperature rises above the comfort zone, the PCM absorbs the heat and cools the air by converting from a solid to a liquid at a constant temperature.

D. Cold storage using PCM

Installing PCMs into air-conditioning systems as cold stor- age devices , based on passive or active air flow exchange of heat occur and provide cooling. Similarly they can be integrated into building's envelope to increase thermal storage density of building which works in the manner of the circu- lation of heat transfer fluid (HTF), which is usually water. In cold storage air-conditioning systems, the PCM is filled into a cold storage device which is placed in the chilled water side of the system, as shown in Fig.16.

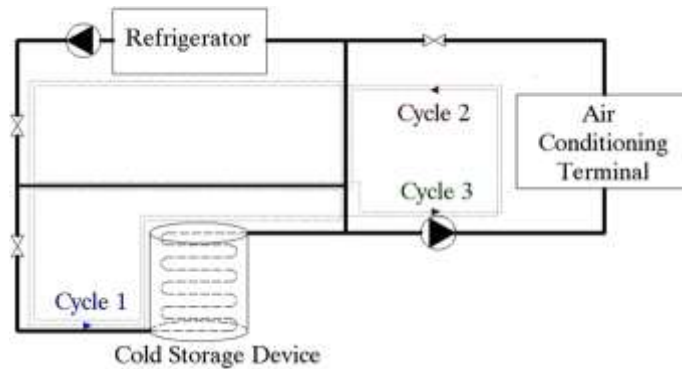

Fig. 16: shows phase change cold storage air-conditioning system

During off peak periods, using water the chiller produces and provides cooling to the cold storage device (cycle 1). When the cooling load gets higher and more cooling is required then the stored cooling energy is released from the storage unit and is supplied to user through air-conditioning terminals (cycle 2). When the stored cooling is not enough to meet the requirement, the chiller starts to provide cooling directly to the user (cycle 3). There are diverse structures of cold storage device, namely spherical capsules packed bed, flat- plate, double tube, shell and tube with internal flow, shell and tube with parallel ow and shell and tube with cross flow.[15]

VII. Pcms For Space Cooling Applications

For the purpose of space cooling, PCM can be integrated into building materials or building components. PCM integra- tion can be done by either microencapsulated PCM which is used to integrate PCM into materials or macroencapsulated PCM which is applied for building components.

A. PCM integrated into walls

Thermal heat storage system can be possible by integrating several kind of PCMs into wall materials like gypsum wall- board, concrete, and masonry bricks .For lightweight dwellings and offices and semi-lightweight schools the analyses showed positive effects on both thermal and energy performance. The greatest effect was seen in lightweight office buildings, where energy savings up to 57% were found In general by considering PCM as a passive building system, results shows a significant improvement in energy saving, peak load shifting etc.[19].

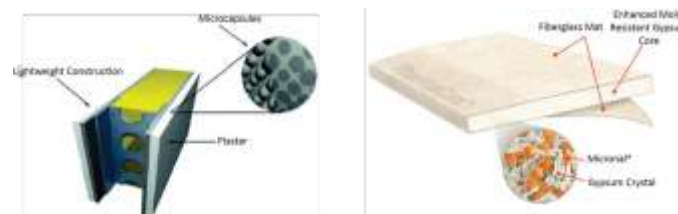

Fig. 17: Schematic view of a lightweight wall. The PCM micro-capsules are integrated into the interior plaster from Thermalcore

B. PCM integrated into ceiling

Heat transfer forced convection is achieved by mixing the PCM with a ceiling construction . Hence, the PCM, which is placed in the channel, can be considered as a heat storage. First, the stored heat is discharged by the cold night air which was conducted across the PCM surface thereby cooling the PCM. Then, the air is evacuated to the outside of the building. Also, during the daytime, since the warm air from the room is forced to move across the PCM, the heat is transmitted to the PCM. As a result, the cooled air is supplied back to the room[43].

C. PCM integrated into floor

Encapsulated PCM or plates are directly placed under the floorings. During the day, cooling is partially provided by absorbing excessive heat from internal loads and PCMs starts to melt. At night, by providing natural ventilation and



Fig. 18: Sketch of the cooling ceiling with PCM plasterboard circulating of outside cold air under the floor space the PCMs starts discharging and change to solid phase. [43].



Fig. 19: Flat profiles which can be installed under floor to store and release latent thermal heat energy

D. PCM integrated into Blinds

Internal blinds are generally preferred to install because they release heat after their temperature is raised due to absorbed solar thermal through the windows. Integration of PCM into blinds improves their thermal performance for using in indoor spaces. The blinds still absorb the same amount of solar radiation, but there would be the PCM lag that keeps the indoor air temperature in the comfort range [43].

E. PCM integrated into Windows

Since the glazed facades suffer from low thermal inertia, and not storing excess heat therefore transparent PCMs are preferred for windows. Goia et al. [44] performed a full-scale test on a PCM glazing prototype. The test was performed on a south-facing wall during summer, mid-season and winter days in a sub-continental climate and compared to a conventional double glazing. Experimental data shows that PCM glazing can reduce the energy gain in the summer by more than

50%. In the winter, heat loss reduction during the day was observed. Several new advanced window technologies such as electrochromic windows, low-e glazing, evacuated glazing, self-cleaning glazing, building integrated photovoltaics (BIPV)

as solar glazing, etc., have been explored

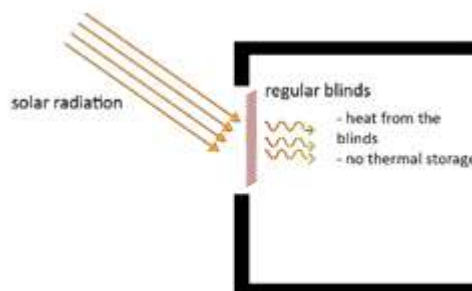

Fig. 20: internal blinds absorb solar radiation and release the heat into the room

VIII. Pcms For Space Heating Applications

For the purpose of keeping the space warm and to avoid the temperature drops below a specific temperature the possible method is reducing the temperature difference. PCM with a suitable melting temperature range within the human comfort is used to store excess heat from solar radiation. Also internal loads during the daytime can be reused during the night time when the temperature drops down.

A. Solar Wall

In a regular wall, temperature difference within the wall results in heat transfer from the heated interior space to the cold outside. But in case of wind the absorbed solar radiation at the wall surface is lost easily through free convection or forced convection. This heat loss can be controlled by means of a transparent insulation because the transparent insulation transmits absorbed solar radiation. Moreover transparent insulation also reduces the heat loss from interior spaces to the outside and this will result in net heat gain to the building interiors. Here the massive wall can be replaced by a thin layer of PCM with the same or higher heat storage capacity. PCM-wall can be constructed using macroencapsulated PCM.

B. PCM with under floor electric heating system

Kunping Lina et al. [46] established a new type of underfloor electric heating system with shape stabilized PCM plates. In this system heat storing takes place during night time for reasonable electricity tariff and released the heat during the daytime. The system were able to increase the room temperature without increasing the temperature difference and significant saving in energy can be achieved as more than half of the total heating loads shift from peak hours to off-peak period.

IX. Future Research Opportunities

1. Finding new material for increasing thermal storage capacity per unit volume
2. Low thermal conductivity problem. Low thermal conductivity reduces the rate of heat absorption or heat release throughout the PCM, i.e. reducing the effectiveness at which it can store and release thermal energy. Hence complete utilisation of latent heat storage of PCM materials not possible. Since larger volume of storage is required for same amount of energy
3. Further work should be done to convert new types of PCMs, new methods to incorporate them into building materials and new heat transfer enhanced techniques in the design of passive LHTES systems.
4. The development of hybrid and adaptable systems to solve the winter and the summer challenge at the same time.
5. Development of new passive systems to take advantage of solar energy.
6. Evaluation of the potential of PCMs towards Net zero energy buildings (NZEBS)

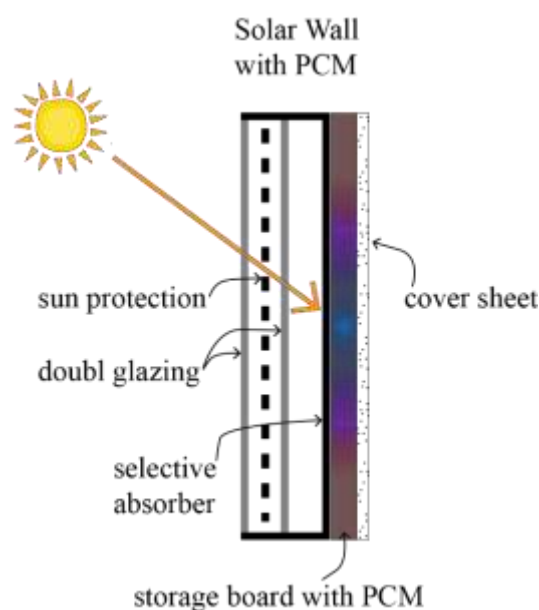

Fig. 21: shows a schematic design of the solar wall [45]

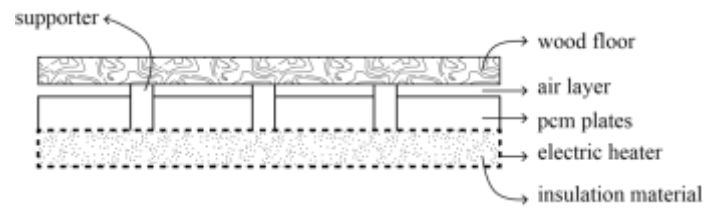

Fig. 22: Schematic of electric floor heating system with shape- stabilized PCM plates[46]

X. Conclusion

- 1..PCM passive Latent heat thermal energy storage(LHTES) systems can contribute to increase indoor thermal comfort,improve buildings envelope, reduce energy consumption, off-peak energy savings, save money and reduction of CO₂ emissions associated to heating and cooling.
2. PCM stores excess energy at elevated temperatures and given back at a certain temperature causing increase in thermal mass at narrow temperature range and relatively high (potential) energy savings is achieved.
3. PCM based free cooling of building is passive technique works in the range between 12° C and 15° C which can be greatly reduce systems electricity consumption and building generated CO₂ emissions as compared to conventional system
4. The phase change cold storage method is capable of improving the efficiency of air-conditioning systems due to the appropriate phase change temperature and high storage density
- 5.The PCMs to be used in buildings need to meet thermal comfort criteria, meaning the phase change temperature of PCMs should be between 18° C to 30° C. In addition, the properties such as chemical stability, fire characteristics and compatibility with constructional materials also need to be considered in the PCMs selections.
- 6.Latent heat storage with PCMs has been used in the walls, ceilings and floors, showing a significant impact on reducing the temperature fluctuation by storing the solar energy during the sunlight hours for passive solar heating. It is also useful for off-peak thermal storage, ventilation and cooling.

References

- [1]. N. Soares , J.J. Costa , A.R. Gaspar , P. Santos Review of passive PCM latent heat thermal energy storage systems towards buildings energy efficiency.Energy and Building 59(2013)82-103
- [2]. Hussein Akeiber , Payam Nejat , Muhd Zaimi Abd. Majid , Mazlan A. Wahid , Fatemeh Jomehzadeh,Iman Zeynali Famileh ,John Kaiser Calautit , Ben Richard Hughes , Sheikh Ahmad Zaki A review on phase change material (PCM) for sustainable passive cooling in building envelopes Renewable and Sustainable Energy Reviews.60 (2016) 14701497
- [3]. Geetha NB, Velraj R. Passive cooling methods for energy efficient buildings with and without thermal energy storage a review. Energy Sci Res 2012;29:91346.
- [4]. Adeel Waqas , Zia Ud Din Phase change material (PCM) storage for free cooling of buildingsA review Renewable and Sustainable Energy Reviews 18 (2013) 607625.
- [5]. H. Mehling, L.F. Cabeza, Heat and Cold Storage with PCM: An Up to Date Introduction into Basics and Applications Springer, 2008.
- [6]. S.B.Sadineni, S. Madala, R.F. Boehm, Passive building energy savings: a review of building envelope components, Renewable and Sustainable Energy Reviews 15 (8) (2011) 36173631.
- [7]. Ruben Baetens , Bjrn Petter Jelle , Arild Gustavsen Phase change materials for building applications: A state-of-the-art review Energy and Buildings 42 (2010) 13611368
- [8]. [Dipl Ing. Jens H. Dieckmann. Latent heat storage in concrete. University of Kaiserslautern, Germany, <http://www.eurosolar.de/>, 2006
- [9]. Sun X, Zhang Q, Medina MA, Lee KO. Experimental observations on the heat transfer enhancement caused by natural convection during melting of solid liquid phase change materials (PCMs). Appl Energy 2016;162:145361..
- [10]. Qian T, Li J, Min X, Deng Y, Guan W, Ning L. Diatomit A promising natural candidate as material for low, middle and high tempera- ture phase change material. Energy Convers Manag 2015;98:3445./
- [11]. M.M. Farid, A.M. Khudhair, S.A.K. Razack, S. Al-Hallaj, A review on phase change energy storage: materials and applications, Energy Conversion and Manage- ment 45 (2004) 15971615.
- [12]. .Sar A, Alkan C, Bilgin C. Micro/nano encapsulation of some paraf- fin eutectic mixtures with poly(methyl methacrylate) shell: preparation, characteriza- tion and latent heat thermal energy storage properties. Appl Energy 2014;136:21727.

- [13]. S.M. Hasnain, Review on sustainable thermal energy storage technologies, Part I: heat storage materials and techniques, *Energy Conversion and Management* 39 (11) (1998) 1127-1138.